

APPLICATION FIBRE OPTICS

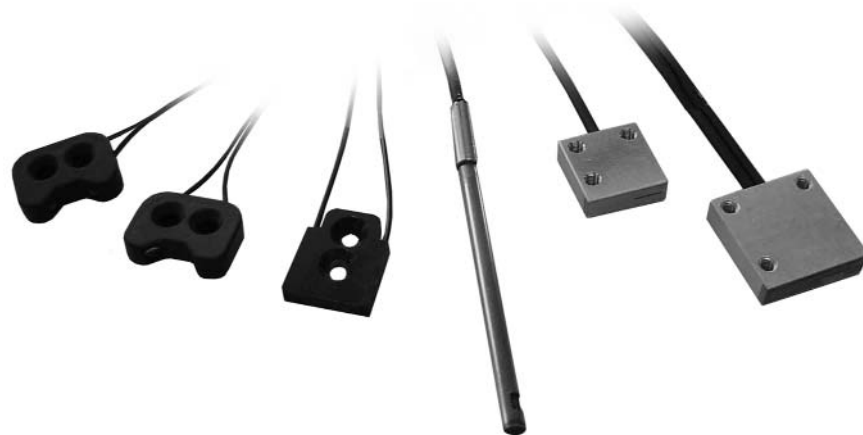

- *Fibre array with parallel beams for proximity or through beam detection*
- *Fixed focus proximity with axial, radial or lateral optics*
- *Proximity with 90° optics, self-contained in the 3.8 mm diameter*
- *Recommended fibres for S7 sensors*

OFA SERIES

The **OFA** series offers advanced fibre optics able to effectively solve critical fibre applications.

The fibre array version with parallel beams increases the detection area avoiding vibrations or target position changes. One single fibre array is able to solve applications previously requiring more aligned fibres, such as the detection of small falling objects or casually varying positions.

The fixed focus proximity version can be used as background suppression as it ignores objects outside the focusing distance, even if more reflective than target. Typical applications include small object detection, such as electronic components or mechanical parts.

The proximity version with 90° optics is the ideal solution for applications with reduced space where the installation of standard emission fibres results impossible.

All the fibres of the **OFA** series have terminals that can be cut to reduce length and are recommended for use with high-resolution sensors of the S7 series.

DIMENSIONS

OFA-1-AE-20

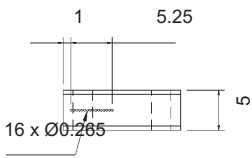
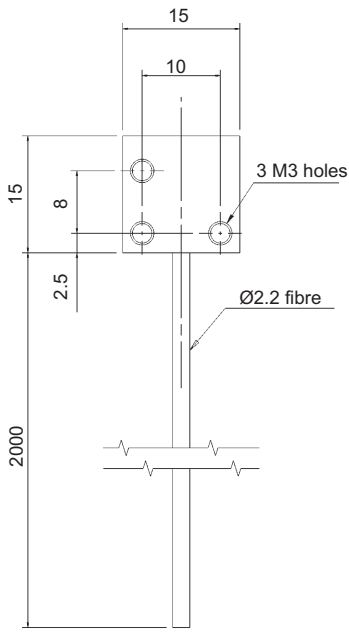

OFA-1-AS-20

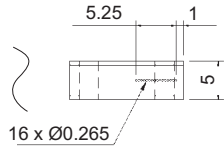
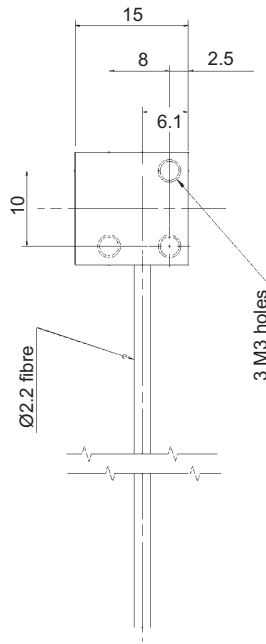

OFA-2-AE-20

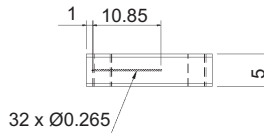
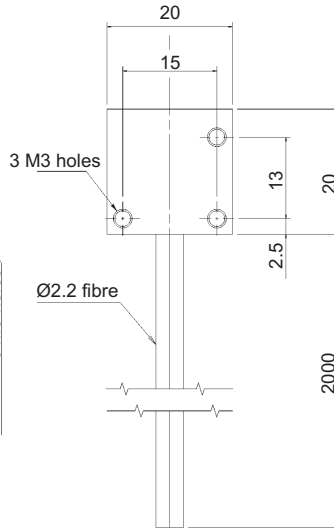

OFA-2-AS-20

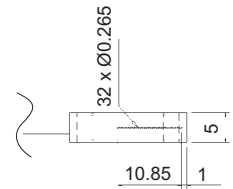
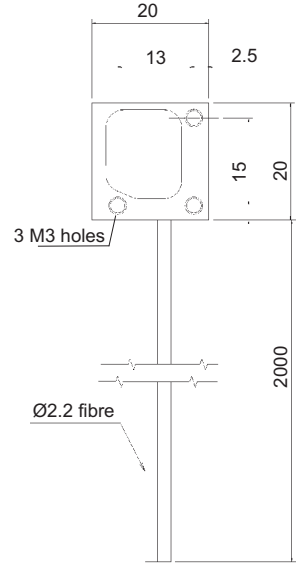

OFA-4-FE-20

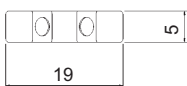
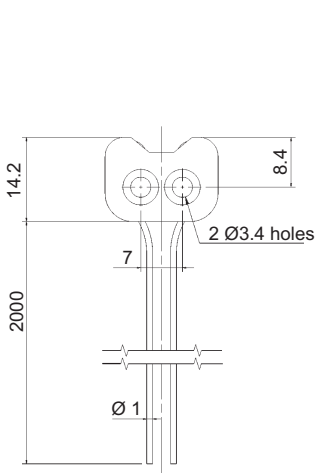

OFA-4-FF-20

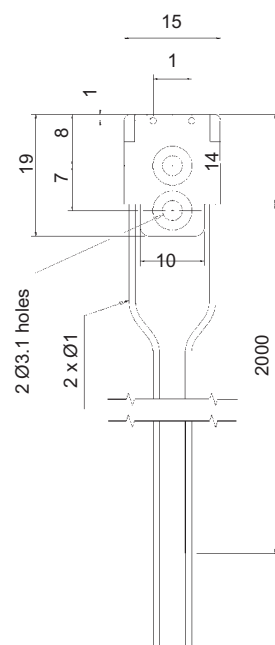

OFA-4-FS-20

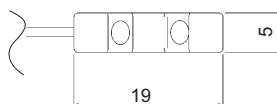
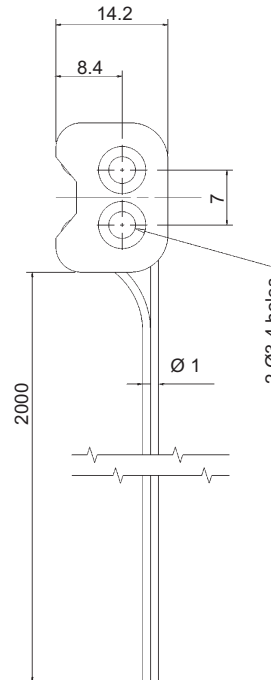

OFA-6-RA-20

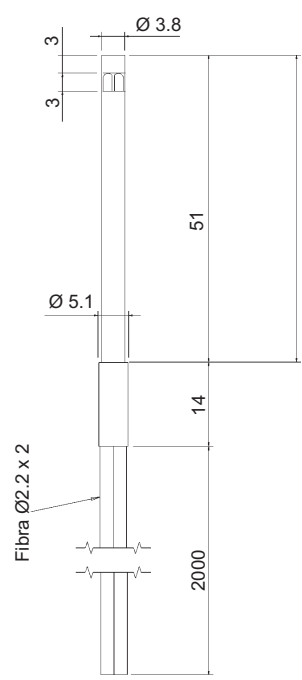

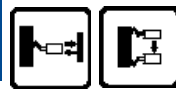

TECHNICAL DATA

		OFA-1-AE-20	OFA-1-AS-20	OFA-2-AE-20	OFA-2-AS-20	OFA-4-FE-20	OFA-4-FS-20	OFA-6-RA-20
Optic function:	through beam	•	•					
	proximity			•	•			•
	fixed focus proximity					•	•	
Emission type:	axial	•	•	•	•	•	•	•
	radial			•	•			•
	lateral					•	•	
Number of beams emitted:	1					•	•	•
	16 parallel	•	•					
	32 parallel			•	•			
External diameter (sheath):	2.2 mm			•	•			•
	2.2 mm	•	•					
	1 mm					•	•	•
Internal diameter (core):	1.5 mm					•	•	•
	32 x 0.265 mm			•	•			
	16 x 0.265 mm	•	•					
	0,5 mm					•	•	•
Bending radius:	10 mm					•	•	•
	25 mm	•	•	•	•			•
Mechanical protection:	IP67	•	•	•	•	•	•	•
Core material:	PMMA plastic	•	•	•	•	•	•	•
Sheath material:	PE plastic	•	•	•	•	•	•	•
Terminal material:	stainless steel							•
	aluminium	•	•	•	•			
	ABS					•	•	•
Cable length:	2 m	•	•	•	•	•	•	•
Operating temperature:	-30...+70°C	•	•	•	•	•	•	•



DETECTION DIAGRAMS

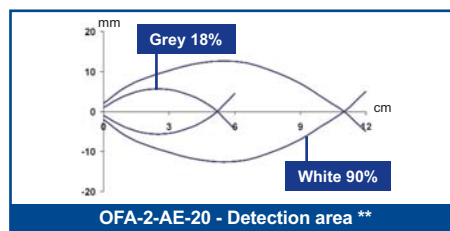
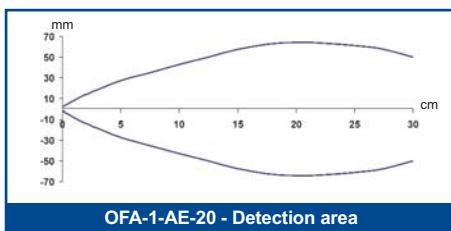
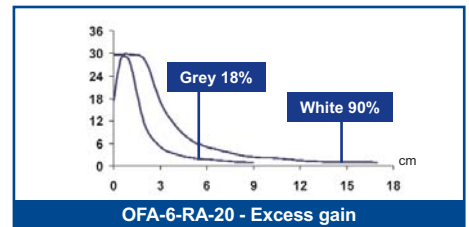
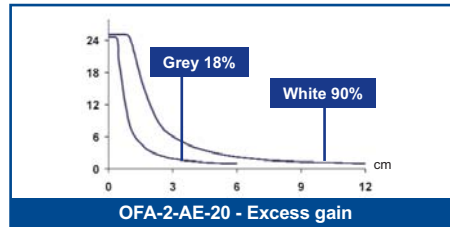
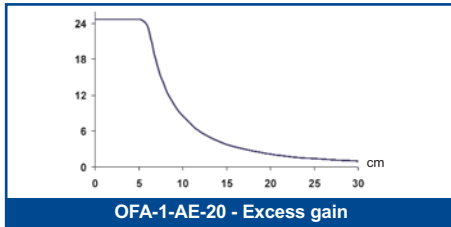

TECHNICAL NOTES

The measurements indicated have been obtained using the S7 fibre-optic sensor with 1 kHz switching frequency and EASYtouch™ acquisition.

The values vary according to the sensor used, switching frequency and target movement.

* Object entering perpendicularly in the fibre optic beam.

** Object entering perpendicularly in the fibre array beam.

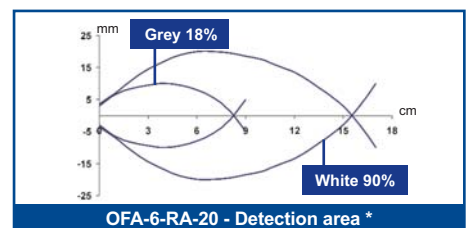
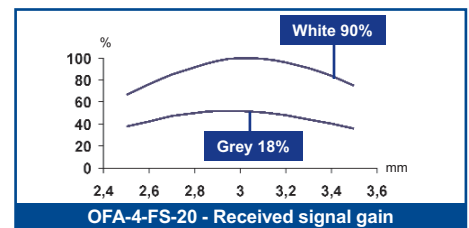
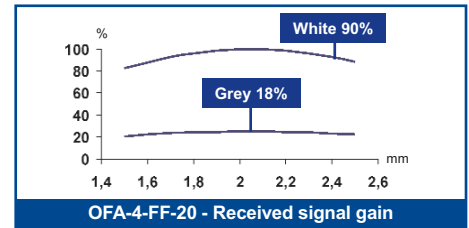
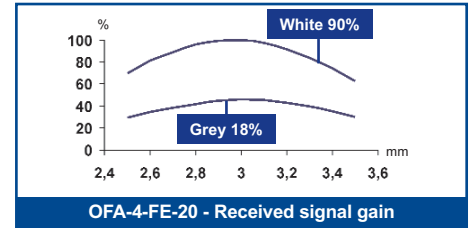
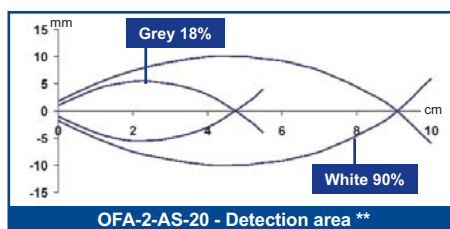
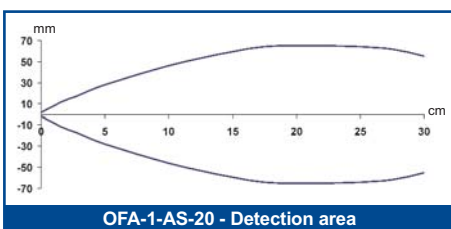
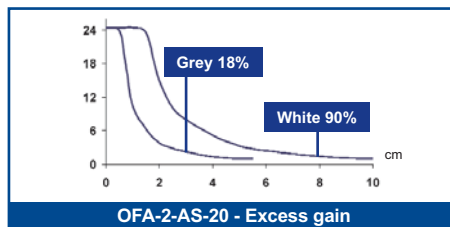
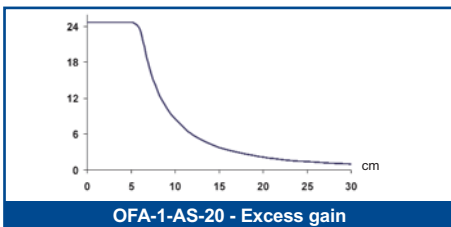

MODEL SELECTION AND ORDER INFORMATION

MODEL	OPTIC FUNCTION	EMISSION	ORDER N°
OFA-1-AE-20	through beam	axial, 16 beam array	95A201170
OFA-1-AS-20	through beam	radial, 16 beam array	95A201180
OFA-2-AE-20	proximity	axial, 32 beam array	95A201150
OFA-2-AS-20	proximity	radial, 32 beam array	95A201160
OFA-4-FE-20	fixed focus proximity	axial	95A201200
OFA-4-FF-20	fixed focus proximity	lateral	95A201210
OFA-4-FS-20	fixed focus proximity	radial	95A201190
OFA-6-RA-20	proximity	radial	95A201140

ACCESSORY SELECTION AND ORDER INFORMATION

MODEL	DESCRIPTION	ORDER N°
AF-11	fibre-cutting tool with Ø 2.2 mm and Ø 1.1 mm holes	95ACC2780

FIBRE OPTICS



Distributed by:

HEADQUARTERS

DATASENSOR SpA
via Lavino, 265 - 40050 Monte San Pietro, BO - Italy
Tel. +39 051/6765611 • Fax +39 051/6759324
www.datasensor.com • e-mail info@datasensor.com

Datasensor SpA endeavours to continuously improve and renew its products; for this reason the technical data and contents of this catalogue may undergo variations without prior notice. For correct installation and use Datasensor SpA can guarantee only the data indicated in the instruction manual supplied with the products.